

# RT10 RUGGED 10-INCH TABLET

Configuration Guide



THE  
FUTURE  
IS  
WHAT  
WE  
MAKE IT

**Honeywell**

# TABLE OF CONTENTS

- 2 RT10 FEATURE OVERVIEW**
  - INDOOR DISPLAY - N6703 STANDARD RANGE
  - OUTDOOR DISPLAY - N6703 STANDARD RANGE
  - INDOOR DISPLAY - N6803 FLEXRANGE™
  - OUTDOOR DISPLAY - N6803 FLEXRANGE™
  
- 6 RT10A CONFIGURATION MAP**
  - ANDROID
  
- 7 RT10W CONFIGURATION MAP**
  - WINDOWS 10 IOT ENTERPRISE
  
- 8 HONEYWELL EDGE SERVICES**
  - RT10 - REPAIR SERVICES
  - GOLD REPAIR SERVICES - 3 YEAR
  - PLATINUM REPAIR SERVICES - 3 YEAR
  - GOLD REPAIR SERVICES - 5 YEAR
  - PLATINUM REPAIR SERVICES - 5 YEAR
  - RT10 - REPAIR SERVICES COVERAGE
  
- 11 RT10 SOFTWARE**
  - RT10 CLIENT PACK OPTIONS
  
- 12 RT10 DESKTOP COMMUNICATIONS**
  - OPTION 1 – PORTABLE
  - OPTION 2 – FIXED - COMMUNICATIONS DOCK
  - OPTION 3 - DISPLAY DOCK
  
- 14 RT10 VEHICLE INSTALL**
  - OPTION 1 - PORTABLE/ SUB CONTRACTOR INSTALL
  - OPTION 2 - PORTABLE/ SUB CONTRACTOR INSTALL
  
- 15 RT10 VEHICLE INSTALL**
  - VEHICLE DOCK OPTIONSVEHICLE DOCK 360 DEGREE VIEW
  - VEHICLE DOCK 360 DEGREE VIEW
  - OPTION 1 - POWER ADAPTER CABLE
  - OPTION 2 - POWER ADAPTER CABLE - IGNITION BYPASS
  
- 19 RT10 FORKLIFT INSTALL**
  - OPTION 1 - WWAN - KEYBOARD - TETHERED SCANNER
  - OPTION 2 - WWAN - KEYBOARD - BLUETOOTH SCANNER
  - OPTION 3 - WWAN - TETHERED SCANNER
  - OPTION 4 - WWAN - BLUETOOTH SCANNER
  
- 23 RT10 PORTS**
  - RT10W AND RT10A I/O PORTS
  
- 24 RT10 BATTERY PACK**
  - STANDARD OR EXTENDED BATTERY
  
- 25 RT10 BATTERY CHARGER**
  - 2 BAY BATTERY CHARGING
  
- 26 RT10 ACCESSORIES**
  - SMART CARD READER
  
- 27 RT10 VESA MOUNT**
  - STATIONARY MOUNTING
  
- 28 GRANIT SCANNER OPTIONS**
  - GRANIT 1981I BLUETOOTH ACCESSORIES
  - GRANIT 1980I - SERIAL CABLE TYPES
  - GRANIT 1980I - USB CABLE TYPES
  
- 31 MISCELLANEOUS**
  - HAND STRAP
  - SHOULDER STRAP
  - STYLUS
  - CARRY BAG
  - OPTIONAL PARTS
  - MICRO-SD CARDS
  - AC CORDS

**INDOOR  
800 NIT**  
Display

  
4G LTE / GPS

  
WiFi / BT

**N6703  
7th GEN**  
Scanner

# RT10 FEATURE OVERVIEW

## Indoor Display – N6703 Standard Range



N6703 Standard Range



Included in the box:

- RT10 Rugged Tablet
- Battery (RT10-BAT-STD1)
- Stylus
- USB Type C Cable (RT10A Only)
- AC Power Supply (No Power Cord)

(AC Power Cord is required, order separately RT10-PWR-CABLE-xx See Page 34 for Country Specific Power Cords)

**RT10W – Windows 10 – 4G WWAN – N6703 – 8GB RAM/ 128GB SSD**

**RT10W-L10-17C12S0x** RT10W 10 inch Windows Rugged Tablet / 8GB/128GB / WWAN / Standard/Indoor Screen / N6703 Standard Range Imager / Front & Rear Cameras / Standard Battery / Windows 10 IoT Enterprise / 802.11abgnac / Bluetooth / Enterprise Client Pack (ECP), No Power Cord

**RT10W – Windows 10 – WiFi Only – N6703 – 8GB RAM/ 128GB SSD**

**RT10W-L00-17C12S0x** RT10W 10 inch Windows Rugged Tablet / 8GB/128GB / WLAN / Standard/Indoor Screen / N6703 Standard Range Imager / Front & Rear Cameras / Standard Battery / Windows 10 IoT Enterprise / 802.11abgnac / Bluetooth / Enterprise Client Pack (ECP), No Power Cord

**RT10A – Android – 4G WWAN – N6703 – 4GB RAM/ 32GB Flash**

**RT10A-L1N-17C12S0x** RT10A 10 inch Android Rugged Tablet / WWAN / Standard/Indoor Screen / N6703 Standard Range Imager / Front & Rear Cameras / Standard Battery / Android GMS / DCP (Device Client Pack) / 802.11abgnac / Bluetooth, No Power Cord

**RT10A – Android – WiFi Only – N6703 – 4GB RAM/ 32GB Flash**

**RT10A-L0N-17C12S0x** RT10A 10 inch Android Rugged Tablet / WLAN / Standard/Indoor Screen / N6703 Standard Range Imager / Front & Rear Cameras / Standard Battery / Android GMS / DCP (Device Client Pack) / 802.11abgnac / Bluetooth, No Power Cord

(Note: x = Domain, select appropriate Domain from Configuration Map on pages 6 & 7)

**Honeywell Repair Services**

SVCRT10-SG3N

RT10, Edge Service, Gold Maintenance Contract, 3 Year, New Contract

ADD SVCREPLACE-MOB3

AddOn, Edge Service, Device Replacement, Mobility, 3 Year

# RT10 FEATURE OVERVIEW

## Outdoor Display - N6703 Standard Range

**OUTDOOR  
800 NIT  
ANTI-GLARE**

Display



4G LTE / GPS



WiFi / BT

**N6703  
7th GEN**

Scanner



N6703 Standard Range



Included in the box:

- RT10 Rugged Tablet
- Battery (RT10-BAT-STD1)
- Stylus
- USB Type C Cable (RT10A Only)
- AC Power Supply (No Power Cord)

(AC Power Cord is required, order separately RT10-PWR-CABLE-xx See Page 34 for Country Specific Power Cords)



**RT10W – Windows 10 – 4G WWAN – N6703 – 8GB RAM/ 128GB SSD**

**RT10W-L10-17C12S1x**

RT10W 10 inch Windows Rugged Tablet / 8GB/128GB / WWAN / Outdoor Screen / N6703 Standard Range Imager / Front & Rear Cameras / Standard Battery / Windows 10 IoT Enterprise / 802.11abgnac / Bluetooth / Enterprise Client Pack (ECP), No Power Cord

**RT10A – Android – 4G WWAN – N6703 – 4GB RAM/ 32GB Flash**

**RT10A-L1N-17C12S1x**

RT10A 10 inch Android Rugged Tablet / WWAN / Outdoor Screen / N6703 Standard Range Imager / Front & Rear Cameras / Standard Battery / Android GMS / DCP (Device Client Pack) / 802.11abgnac / Bluetooth, No Power Cord

(Note: x = Domain, select appropriate Domain from Configuration Map on pages 6 & 7)

### Honeywell Repair Services

SVCRT10-SG3N

RT10, Edge Service, Gold Maintenance Contract, 3 Year, New Contract

ADD SVCREPLACE-MOB3

AddOn, Edge Service, Device Replacement, Mobility, 3 Year

**INDOOR  
800 NIT**  
Display

  
4G LTE / GPS

  
WiFi / BT

**N6803  
8th GEN**  
Scanner

# RT10 FEATURE OVERVIEW

## Indoor Display – N6803 FlexRange™



Included in the box:

- RT10 Rugged Tablet
- Battery (RT10-BAT-STD1)
- Stylus
- USB Type C Cable (RT10A Only)
- AC Power Supply (No Power Cord)

(AC Power Cord is required, order separately RT10-PWR-CABLE-xx See Page 34 for Country Specific Power Cords)

### RT10W – Windows 10 – 4G WWAN – N6803 FlexRange – 8GB RAM/ 128GB SSD

**RT10W-L10-18C12S0x** RT10W 10 inch Windows Rugged Tablet / 8GB/128GB / WWAN / Standard/Indoor Screen / N6803 FlexRange Imager / Front & Rear Cameras / Standard Battery / Windows 10 IoT Enterprise / 802.11abgnac / Bluetooth / Enterprise Client Pack (ECP), No Power Cord

### RT10W – Windows 10 – WiFi Only – N6803 FlexRange – 8GB RAM/ 128GB SSD

**RT10W-L00-18C12S0x** RT10W 10 inch Windows Rugged Tablet / 8GB/128GB / WLAN / Standard/Indoor Screen / N6803 FlexRange Imager / Front & Rear Cameras / Standard Battery / Windows 10 IoT Enterprise / 802.11abgnac / Bluetooth / Enterprise Client Pack (ECP), No Power Cord

### RT10A – Android – 4G WWAN – N6803 FlexRange – 4GB RAM/ 32GB Flash

**RT10A-L1N-18C12S0x** RT10A 10 inch Android Rugged Tablet / WWAN / Standard/Indoor Screen / N6803 FlexRange Imager / Front & Rear Cameras / Standard Battery / Android GMS / DCP (Device Client Pack) / 802.11abgnac / Bluetooth, No Power Cord

### RT10A – Android – WiFi Only – N6803 FlexRange – 4GB RAM/ 32GB Flash

**RT10A-L0N-18C12S0x** RT10A 10 inch Android rugged tablet / WLAN / Standard/Indoor Screen / N6803 FlexRange Imager / Front & Rear Cameras / Standard Battery / Android GMS / DCP (Device Client Pack) / 802.11abgnac / Bluetooth, No Power Cord

(Note: x = Domain, select appropriate Domain from Configuration Map on pages 6 & 7)

#### Honeywell Repair Services

SVCRT10-SG3N

RT10, Edge Service, Gold Maintenance Contract, 3 Year, New Contract

ADD SVCREPLACE-MOB3

AddOn, Edge Service, Device Replacement, Mobility, 3 Year

# RT10 FEATURE OVERVIEW

## Outdoor Display - N6803 FlexRange™

**OUTDOOR  
800 NIT  
ANTI-GLARE**

Display



4G LTE / GPS



WiFi / BT

**N6803  
8th GEN**

Scanner



Included in the box:

- RT10 Rugged Tablet
- Battery (RT10-BAT-STD1)
- Stylus
- USB Type C Cable (RT10A Only)
- AC Power Supply (No Power Cord)

(AC Power Cord is required, order separately RT10-PWR-CABLE-xx See Page 34 for Country Specific Power Cords)



### RT10W – Windows 10 - 4G WWAN – N6803 FlexRange – 8GB RAM/ 128GB SSD

**RT10W-L10-18C12S1x** RT10W 10 inch Windows Rugged Tablet / 8GB/128GB / WWAN / Outdoor Screen / N6803 FlexRange Imager / Front & Rear Cameras / Standard Battery / Windows 10 IoT Enterprise / 802.11abgnac / Bluetooth / Enterprise Client Pack (ECP), No Power Cord

### RT10A – Android - 4G WWAN – N6803 FlexRange – 4GB RAM/ 32GB Flash

**RT10A-L1N-18C12S1x** RT10A 10 inch Android Rugged Tablet / WWAN / Outdoor Screen / N6803 FlexRange Imager / Front & Rear Cameras / Standard Battery / Android GMS / DCP (Device Client Pack) / 802.11abgnac / Bluetooth, No Power Cord

(Note: x = Domain, select appropriate Domain from Configuration Map on pages 6 & 7)

#### Honeywell Repair Services

SVCRT10-SG3N



RT10, Edge Service, Gold Maintenance Contract, 3 Year, New Contract

ADD SVCREPLACE-MOB3

AddOn, Edge Service, Device Replacement, Mobility, 3 Year

# RT10A CONFIGURATION MAP



## Android

RT10A-												DESCRIPTION	NOTES
BLUETOOTH/WIFI	WWAN	NFC	MEMORY	IMAGER	CAMERA	OPERATING-SYSTEM	APPLICATION	BATTERY	CUSTOM	DOMAIN			
L												802.11 a/b/g/n/ac + Bluetooth 5.0	2x2 MIMO IEEE 802.11 a/b/g/n/ac/r/k/mc ; Wi-Fi certified V5.0 Bluetooth and BLE Supported Bluetooth Profiles: HFP,PBAP, A2DP, AVRCP, OPP, SPP, GATT
	0											No WWAN	
	1											LTE (4G) GPS, UMTS/HSPA+ (3G) GSM/GPRS/EDGE	WWAN RADIO (ATT/VZW/SPRINT/TMO/NA/EU) LTE (FDD) – BANDS 1,2,3,4,5,7,8,12,13,17,19,20,25,26,28,29 LTE (TDD) – BANDS 38,39,40,41 UMTS/HSPA+ (3G) – BANDS 1, 2, 4, 5, 6, 8, 9, 19 / GSM/GPRS/EDGE QUAD-BAND (850/900/1800/1900 MHZ)
		N										Near Field Communications (NFC)	
		--											
			1									4GB RAM, 32GB Flash Memory	2.2 GHz Qualcomm Snapdragon™ 660 octa-core
				7								1D/2D Imager (N6703) – Standard Range	
				8								1D/2D Imager (N6803) – FlexRange™	
					C							Camera	8MP Front and 13MP Rear
					N							No Camera	
						1						Android (GMS)	Google Mobile Services (GMS) certified – Play Store
						2						Android (Non-GMS)	
							2					Device Client Pack (DCP) - 1 Year Term + Maintenance License	DCP-SFT1 - Enterprise Browser, Basic TE and Honeywell Launcher
								S				Standard Battery	RT10-BAT-STD1 Standard (5,900mAh)
								E				Extended Battery	RT10-BAT-EXT1 Extended (10,280mAh)
									0			Indoor Display 800 NIT Display	
									1			Outdoor Display 800 NIT Display (Anti-Reflective Film)	Anti-Reflective Film is applied at Manufacturing, not field installable.
										C		China	China
										E		World Wide	Argentina, Australia, Austria, Belgium, Brazil, Bulgaria, Columbia, Croatia, Cyprus, Czech Republic, Denmark, Dominican Republic, Egypt, Estonia, Finland, France, Germany, Greece, Honduras, Hong Kong, Iceland, India, Indonesia, Ireland, Italy, Japan, Jordan, Kuwait, Latvia, Liechtenstein, Lithuania, Luxembourg, Malaysia, Malta, Morocco, Netherlands, New Zealand, Norway, Oman, Poland, Portugal, Qatar, Romania, Russia, Saudi Arabia, Singapore, Slovakia, Slovenia, South Africa, South Korea, Spain, Sri Lanka, Sweden, Switzerland, Thailand, UAE, Ukraine, United Kingdom, Vietnam
										F		FCC	USA, Canada, Guatemala, Mexico, Panama, Paraguay, Puerto Rico, Taiwan, Venezuela



# RT10W CONFIGURATION MAP

## Windows 10 IoT Enterprise

											DESCRIPTION	NOTES		
BLUETOOTH/WIFI	WWAN	NFC	MEMORY	IMAGER	CAMERA	OPERATING SYSTEM	APPLICATION	BATTERY	CUSTOM	DOMAIN				
<b>RT10W-</b>														
L												802.11 a/b/g/n/ac + Bluetooth 5.0		
	0											No WWAN		
		1										LTE (4G) GPS, UMTS/HSPA+ (3G)	WWAN RADIO LTE (FDD) – BANDS 1,2,3,4,5,7,8,12,13,20,25,26,29,30 / LTE (TDD) – BAND 41 UMTS/HSPA+ (3G) – BANDS 1, 2, 3, 4, 5, 8	
			0									No Near Field Communications (NFC)		
				--										
				1								8GB RAM, 128GB SSD	Intel® Pentium® N4200 Apollo Lake Processor 1.10 GHz, up to 2.50 GHz with turbo boost technology	
					7							1D/2D Imager (N6703) – Standard Range		
						8						1D/2D Imager (N6803) – FlexRange™		
							C					Camera	2MP Front and 8MP Rear	
								N				No Camera		
									1			Windows® 10 IoT Enterprise (64-bit)		
										2		Enterprise Client Pack (ECP)	Windows Enterprise Terminal Emulator (ETE) + Launcher + Enterprise Browser	
											S	Standard Battery	RT10-BAT-STD1 Standard (5,900mAh)	
												E	Extended Battery	RT10-BAT-EXT1 Extended (10,280mAh)
												0	Indoor Display 800 NIT Display	
												1	Outdoor Display 800 NIT Display (Anti-Reflective Film)	Anti-Reflective Film is applied at Manufacturing, not field installable.
												C	China	China
												E	World Wide	Argentina, Australia, Austria, Belgium, Brazil, Bulgaria, Columbia, Croatia, Cyprus, Czech Republic, Denmark, Dominican Republic, Egypt, Estonia, Finland, France, Germany, Greece, Honduras, Hong Kong, Iceland, India, Indonesia, Ireland, Italy, Japan, Jordan, Kuwait, Latvia, Liechtenstein, Lithuania, Luxembourg, Malaysia, Malta, Morocco, Netherlands, New Zealand, Norway, Oman, Poland, Portugal, Qatar, Romania, Russia, Saudi Arabia, Singapore, Slovakia, Slovenia, South Africa, South Korea, Spain, Sri Lanka, Sweden, Switzerland, Thailand, UAE, Ukraine, United Kingdom, Vietnam
												F	FCC	USA, Canada, Guatemala, Mexico, Panama, Paraguay, Puerto Rico, Taiwan, Venezuela





# HONEYWELL EDGE SERVICES

## RT10 – Repair Services

Honeywell Edge Services give you the confidence of having leading-class technologies combined with service and support plans that are designed to keep you operational for longer.

### Gold Repair Services – 3 Year

The most flexible contract in the industry. The Edge Services Gold Support contract allows you to select the right coverage for your organization, and includes 5-Day Depot Repairs and:

#### Service Overview

- Repair or replacement of damaged components, wear and tear, and accidental damage.
- Android Service is included with the flexibility to add any Add-On Service

PART NUMBER	DESCRIPTION
SVCRT10-SG3N	RT10, Edge Service, GOLD Maintenance Contract, 5 Day Turnaround, <b>3 Year</b> , New Contract

#### Add-On Accessory Replacement Service

Provides replacement chargers, docks, charging cables, or scan handles should they be damaged or stop working.

<b>ADD</b> SVCACC-MOB3	AddOn, Edge Service, Accessory Service , Mobility, <b>3 Year</b> . Service covers docks, charger cradles, scan handles
------------------------	--

#### Add-On Battery Replacement Service

Provides replacement batteries every 18 months after purchase.

<b>ADD</b> SVCBATTERY-MOB3	AddOn, Edge Service, Battery Service, Mobility, <b>3 Year</b> , 1 Replacement Battery over life of contract
----------------------------	---

#### Add-On Device Replacement Service

Replacement devices should a device be damaged beyond repair.

<b>ADD</b> SVCREPLACE-MOB3	AddOn, Edge Service, Device Replacement, Mobility, <b>3 Year</b>
----------------------------	--

#### Add-On Image Management Service

Ensures that when a device returns from being repaired, it has all the proper applications loaded back on the device.

<b>ADD</b> SVCIMAGEMGMT-MOB3	AddOn, Edge Service, Image Service, Mobility, <b>3 Year</b>
------------------------------	---

#### Add-On Spare Management Service

Manages every aspect of your spare pool.

<b>ADD</b> SVCSPAREMGMT-MOB3	AddOn, Edge Service, Advanced Exchange, Mobility, <b>3 Year</b> . Customer owned spare pool, Minimum Purchase required, contact your local Honeywell Service Representative for more information.
------------------------------	---

#### Add-On Sentinel Extended Service

Security patches and minor enhancements to legacy Android operating systems, typically added after year 3.

<b>ADD</b> SVCSENTINEL-MOB1	Sentinel Service, <b>1 Year</b> Android Support Contract
<b>ADD</b> SVCSENTINEL-MOB2	Sentinel Service, <b>2 Year</b> Android Support Contract

### Platinum Repair Services – 3 Year

The Edge Services Platinum Support contract is the only total support contract in the industry today offering 2-Day Depot Repairs or Spare Pool Management with 3-year contract, that includes:

#### Service Overview

- Repair or replacement of damaged components
- SVCREPLACE-MOB3 - Replacement devices should a device be damaged beyond repair
- SVCACC-MOB3 - Accessory replacement service
- SVCBATTERY-MOB3 - Battery replacement service
- SVCSPAREMGMT-MOB3 - Spare pool management (optional, minimum quantity required)
- Telephone-based technical support
- Sentinel Extended Service that protects customers for future security updates on Android.

PART NUMBER	DESCRIPTION
SVCRT10-SP3N	RT10, Edge Service, PLATINUM, 2 Day Turnaround, 3 Year, New Contract



# HONEYWELL EDGE SERVICES

## RT10 – Repair Services

Honeywell Edge Services give you the confidence of having leading-class technologies combined with service and support plans that are designed to keep you operational for longer.

### Gold Repair Services – 5 Year

The most flexible contract in the industry. The Edge Services Gold Support contract allows you to select the right coverage for your organization, and includes 5-Day Depot Repairs and:

#### Service Overview

- Repair or replacement of damaged components, wear and tear, and accidental damage.
- Android Service is included with the flexibility to add any Add-On Service

PART NUMBER	DESCRIPTION
SVCRT10-SG5N	RT10, Edge Service, GOLD Maintenance Contract, 5 Day Turnaround, <b>5 Year</b> , New Contract

#### Add-On Accessory Replacement Service

Provides replacement chargers, docks, charging cables, or scan handles should they be damaged or stop working.

<b>ADD</b> SVCACC-MOB5	AddOn, Edge Service, Accessory Service , Mobility, <b>5 Year</b> . Service covers docks, charger cradles, scan handles
------------------------	--

#### Add-On Battery Replacement Service

Provides replacement batteries every 18 months after purchase.

<b>ADD</b> SVCBATTERY-MOB5	AddOn, Edge Service, Battery Service, Mobility, <b>5 Year</b> , 2 Replacement Battery over life of contract
----------------------------	---

#### Add-On Device Replacement Service

Replacement devices should a device be damaged beyond repair.

<b>ADD</b> SVCREPLACE-MOB5	AddOn, Edge Service, Device Replacement, Mobility, <b>5 Year</b>
----------------------------	--

#### Add-On Image Management Service

Ensures that when a device returns from being repaired, it has all the proper applications loaded back on the device.

<b>ADD</b> SVCIMAGEMGMT-MOB5	AddOn, Edge Service, Image Service, Mobility, <b>5 Year</b>
------------------------------	---

#### Add-On Spare Management Service

Manages every aspect of your spare pool.

<b>ADD</b> SVCSPAREMGMT-MOB5	AddOn, Edge Service, Advanced Exchange, Mobility, <b>5 Year</b> . Customer owned spare pool, Minimum Purchase required, contact your local Honeywell Service Representative for more information.
------------------------------	---

#### Add-On Sentinel Extended Service

Security patches and minor enhancements to legacy Android operating systems, typically added after year 3.

<b>ADD</b> SVCSENTINEL-MOB1	Sentinel Service, <b>1 Year</b> Android Support Contract
-----------------------------	--

<b>ADD</b> SVCSENTINEL-MOB2	Sentinel Service, <b>2 Year</b> Android Support Contract
-----------------------------	--

### Platinum Repair Services – 5 Year

The Edge Services Platinum Support contract is the only total support contract in the industry today offering 2-Day Depot Repairs or Spare Pool Management with 5-year contract, that includes:

#### Service Overview

- Repair or replacement of damaged components
  - SVCREPLACE-MOB5 - Replacement devices should a device be damaged beyond repair
  - SVCACC-MOB5 - Accessory replacement service
  - SVCBATTERY-MOB5 - Battery replacement service
  - SVCSPAREMGMT-MOB5 - Spare pool management (optional, minimum quantity required)
  - Telephone-based technical support
  - Sentinel Extended Service that protects customers for future security updates on Android.
- RT10A - The 5 year Sentinel coverage provides extended Android updates in years 4 and 5.

PART NUMBER	DESCRIPTION
SVCRT10-SP5N	RT10, Edge Service, PLATINUM, 2 Day Turnaround, 5 Year, New Contract



# HONEYWELL REPAIR SERVICES

## RT10 – Repair Services Coverage

For Best-In-Class Service

RT10



Warranty Cover Against Product Defect

BASIC Service

Gold Coverage:

- Accidental Damage
- Wear & Tear

Includes Replacement of:

- Stylus



Flexible GOLD Add-Ons ordered separately

- SVCACC-MOB3                      Accessories
- SVCBATTERY-MOB3              Batteries
- SVCREPLACE-MOB3              Device Replacement
- SVCIMAGEMGMT-MOB3          Image Service
- SVCSPAREMGMT-MOB3          Advanced Exchange

GOLD Service

Platinum Coverage

- Battery Replacement
- Coverage for Docks/ Chargers
- Sentinel Extended Service for Android Security Updates
- Accidental Damage
- Device Replacement
- Wear & Tear



Battery Chargers



Vehicle Dock



Car Chargers



Battery  
(3 Year – 1 replacement battery per RT10)  
(5 Year – 2 replacement batteries per RT10)



Docks



Dock Power Supplies

PLATINUM Service

PART NUMBER	DESCRIPTION
SVCRT10-EXW4	RT10, BASIC, 10-15 Day Turnaround, 4 Years (3 Year Factory Warranty + 1 Year Extended)
SVCRT10-SG3N	RT10, Edge Service, GOLD Maintenance Contract, 5 Day Turnaround, 3 Year, New Contract
<b>ADD</b> SVCACC-MOB3	AddOn, Edge Service, Accessory Service , Mobility, 3 Year. Service covers docks, charger cradles, scan handles and car adapter
<b>ADD</b> SVCBATTERY-MOB3	AddOn, Edge Service, Battery Service, Mobility, 3 Year, 1 Replacement Battery over life of contract
<b>ADD</b> SVCREPLACE-MOB3	AddOn, Edge Service, Device Replacement, Mobility, 3 Year
<b>ADD</b> SVCIMAGEMGMT-MOB3	AddOn, Edge Service, Image Service, Mobility, 3 Year
<b>ADD</b> SVCSPAREMGMT-MOB3	AddOn, Edge Service, Advanced Exchange, Mobility, 3 Year. Customer owned spare pool, Minimum Purchase required.
SVCRT10-SP3N	RT10, Edge Service, PLATINUM, 2 Day Turnaround, 3 Year, New Contract

# RT10 SOFTWARE

## RT10 Client Pack Options

Perpetual Licenses operate without expiration for the authorized software version features, and includes 1 year of Maintenance. Add on Maintenance separately. Term + Maintenance Licenses provide software operation, software new version features, and tech support, all for a defined period.

### RT10A - Android



All RT10A units will ship with Device Client Pack Term + Maintenance license (DCP-SFT1) which includes first year operation and maintenance support.

SmartTE is Pre-Loaded, but requires license SMARTTE-001 to be purchased separately.

### RT10A - Device Client Pack





Launcher





Enterprise Browser





Basic TE



PART NUMBER	DESCRIPTION
DCP-001	Device Client Pack Perpetual License (DCP) includes 1 Year Software Maintenance. License covers Launcher, Enterprise Browser, BasicTE, and Mobility Web SDK. Purchase DCP-SFTx prior to maintenance expiring.
DCP-SFT1	Device Client Pack - 1 Year Term + Maintenance (Launcher, Enterprise Browser & BasicTE)
DCP-SFT3	Device Client Pack - 3 Year Term + Maintenance (Launcher, Enterprise Browser & BasicTE)
DCP-SFT5	Device Client Pack - 5 Year Term + Maintenance (Launcher, Enterprise Browser & BasicTE)

### Order Separately



SmartTE Terminal Emulator



PART NUMBER	DESCRIPTION
SMARTTE-001	SMARTTE - SINGLE PATH W-1 Year Maintenance
SMARTTE-SFT3	SMARTTE - 3 Year Software Maintenance
SMARTTE-SFT5	SMARTTE - 5 Year Software Maintenance

### RT10W - Enterprise Client Pack

### RT10W - Windows 10



All RT10W units will ship with Enterprise Client Pack Term + Maintenance license (CLIENTPACK-SFT1) which includes first year operation and maintenance support.





Launcher





Enterprise Browser





Windows TE



PART NUMBER	DESCRIPTION
CLIENTPACK-001	Perpetual License, Enterprise Browser, Launcher and Windows TE, includes 1 Year of Software Maintenance. Purchase CLIENTPACK-SFTx prior to maintenance expiring.
CLIENTPACK-SFT1	Software Maintenance - Client Pack - 1 Year Term + Maintenance (Launcher, Enterprise Browser & Windows TE)
CLIENTPACK-SFT3	Software Maintenance - Client Pack - 3 Year Term + Maintenance (Launcher, Enterprise Browser & Windows TE)
CLIENTPACK-SFT5	Software Maintenance - Client Pack - 5 Year Term + Maintenance (Launcher, Enterprise Browser & Windows TE)

# RT10 DESKTOP COMMUNICATIONS

## Option 1 – Portable

USB Communication to PC/ Mac OR Snap-On Charging



IEC-C6 Connector

PART NUMBER	DESCRIPTION
1 RT10-PWR	Spare Power Adaptor. 100-240VAC to 19VDC at 3.42A. Requires Country Specific Power Cord.
2 CBL-500-120-S00-05	USB type A to type C, 1.2 m (3.9 ft)
3 **	AC Power Cord – See Page 34 for Country Specific Power Cords

## Option 2 – Fixed – Communications Dock

Ports: 2x USB 2.0 Side, 2x USB 2.0 Rear, RS232, 1x RJ45 Ethernet, VGA.



Rear View



PART NUMBER	DESCRIPTION
1 RT10-CD	Communications Dock, 12-19V DC. must order Power Supply and AC Power Cord separately.
2 RT10-PWR	Spare Power Adaptor. 100-240VAC to 19VDC at 3.42A. Requires Country Specific Power Cord. (RT10 units ship with power supply which can be used with RT10-CD).
3 **	AC Power Cord – See Page 34 for Country Specific Power Cords

**OPTIONAL** CBL-500-120-S00-05 USB type A to type C, 1.2 m (3.9 ft)

# RT10 DESKTOP COMMUNICATIONS

## Option 3 - Display Dock

Connect USB peripherals (keyboard, mouse) and External Monitor via HDMI



POWER USB A HDMI Ethernet  
Rear View



PART NUMBER	DESCRIPTION
1 RT10-DD	Display Dock for connecting to external monitor. Ports: 1x RJ45 Ethernet, 3x USB-A, 1x HDMI, RT10 pogo-pin dock connector. Kit includes Display Base Only, must order Power Supply, Power Cord and HDMI cable separately.
2 RT10-PWR	Spare Power Adaptor. 100-240VAC to 19VDC at 3.42A. Requires Country Specific Power Cord. (RT10 units ship with power supply which can be used with RT10-DD).
3 **	AC Power Cord - See Page 34 for Country Specific Power Cords

# RT10 VEHICLE INSTALL

## Option 1 - Portable/ Sub Contractor Install

Simple Vehicle Charging, portable between vehicles



**PART NUMBER**      **DESCRIPTION**

<b>1</b>	RT10-MC	Vehicle charger / cigarette lighter adapter. 11-16V & 22-24V DC input, 19V / 3.42A DC output.
----------	---------	---

## Option 2 - Portable/ Sub Contractor Install

Ports: 4x USB-A, 1x RS-232, 1x RJ45 Ethernet, 1x GPS antenna



RT10-VD Vehicle Dock I/O Ports  
Bottom View



- | Includes:
- | 1 x Terminal Block Plug
- | 1 x Power Cable (Cigarette Receptacle to Terminal Block)
- | 4 x Screws (M4-6mm) for VESA mount



**PART NUMBER**      **DESCRIPTION**

<b>1</b>	RT10-VC	Vehicle Cradle - <b>Power Only</b> . 3-pin terminal block 9-36V power supply.
<b>OR</b>	RT10-VD	Vehicle Dock, 3-pin terminal block 9-36V power supply. Easy insert and release with key-lock. Ports: 4x USB-A, 1x RS-232, 1x RJ45 Ethernet, 1x GPS antenna
<b>2</b>	RT10-MNT-RAM	75x75mm VESA Plate with 2.25" diameter rubber ball "D" size.

# RT10 VEHICLE INSTALL

## Vehicle Dock Options

Choose between Power Only Cradles or Vehicle Dock with I/O Communications.



**PART NUMBER**    **DESCRIPTION**

RT10-VC    Vehicle Cradle - **Power Only**. 3-pin terminal block 9-36V power supply. Easy insert and release with key-lock.



**PART NUMBER**    **DESCRIPTION**

RT10-VD    Vehicle Dock, 3-pin terminal block 9-36V power supply. (RS232 port NOT compatible with Granit, use RT10-EVD) Easy insert and release with key-lock. Ports: 4x USB-A, 1x RS-232, 1x RJ45 Ethernet, 1x GPS antenna



**PART NUMBER**    **DESCRIPTION**

RT10-EVC    Enhanced Vehicle Cradle - power only. VM compatible 10-60V power supply. Easy insert and release with key-lock, includes RT10-IGNITION-CABLE adapter cable which directs power to all RT10 Docks on forklifts with no separate ignition control.



**PART NUMBER**    **DESCRIPTION**

RT10-EVD    Enhanced Vehicle Dock. VM compatible 10-60V power supply. Easy insert and release with key-lock. Ports: 2x USB-A, 2x RS-232, 1x D-9 USB, RJ45 Ethernet, includes RT10-IGNITION-CABLE adapter cable which directs power to all RT10 Docks on forklifts with no separate ignition control. COM1/ COM2 RS232 Port provides +5V DC (500mA max) on Pin 9 and is compatible with Granit Scanners



# RT10 VEHICLE INSTALL

## Vehicle Dock 360 degree view



Side View



Rear View

Recommended Screws M4 6mm, longer screws may be required if attaching other RAM plates or accessories.



Angle View

# RT10 VEHICLE INSTALL

## Vehicle Dock 360 degree view



Rear View

RT10-MNT-RAM 75x75mm VESA Plate with 2.25" diameter rubber ball "D" size.  
Mounting Pattern Overlay



RT10-EVD

# RT10 VEHICLE INSTALL

## Option 1 - Power Adapter Cable

3-Pin Terminal Block to VMx Adapter Cable



RT10-VC or RT10-VD 3-Pin Terminal Block



VM1055CABLE



**PART NUMBER**

**DESCRIPTION**

1

RT10-VM-POWER-CVRT

VM to 3-Pin Power Adapter Cable (Adapt VM1055CABLE to 3-Pin for RT10-VC or RT10-VD docks)

## Option 2 - Power Adapter Cable - Ignition Bypass

Ignition Bypass cable is required for powering RT10-EVC or RT10-EVD when not using ignition wiring.



RT10-EVC or RT10-EVD VMx Power Connector



VM1055CABLE



**PART NUMBER**

**DESCRIPTION**

1

RT10-IGNITION-CABLE

RT10 Ignition Cable - Directs power to RT10-EVC or RT10-EVD Docks on forklifts that do not use separate ignition control (powered directly). If the forklift install uses ignition control, this bypass adapter cable is not required.

# RT10 FORKLIFT INSTALL

## Option 1 - WWAN - Keyboard - Tethered Scanner



**PART NUMBER DESCRIPTION**

<b>1</b>	RT10A-L1N-18C11SOx	RT10 WWAN / FlexRange / Device Client Pack
<b>2</b>	RT10-EVD	Enhanced Vehicle Dock, 10 to 60 VDC (Requires VM1055CABLE)
<b>3A</b>	RT10-2012BRKTKIT	RAM mount kit, keyboard, Round Base, Medium arm 8.5inch (215 mm)
<b>4</b>	9000160KEYBRD	Windows Laptop Style 95 key rugged keyboard with integrated 2 button mouse, DB9M USB Interface
<b>5</b>	VM1055CABLE	VM1, VM2, VM3 DC power cable right angle (spare)
<b>6</b>	1980iFR-3SER	1980iFR-3: 1D/2D, FR focus (EX20), red scanner (1980iFR-3), RS232

**OPTIONAL**

<b>7</b>	TOOLBAL	Scanner take up reel/balancer
<b>8</b>	VMHOLDER2K	Vehicle Mount Cup: Contains vehicle mount Granit scanner cup with 1' ball joint attachment. Recommended use with VMHOLDER3K (mounting arm with round attachment plate) or VMHOLDER4K (mounting arm with vehicle clamp), not included.

**SERVICE**

<b>SVCRT10-SG3N</b>	RT10, Edge Service, GOLD Maintenance Contract, 5 Day Turnaround, 3 Year, New Contract	
<b>SVCACC-MOB3</b>	AddOn, Edge Service, Accessory Service, Mobility, 3 Year.	
<b>3B</b>	RT10-2015BRKTKIT	RAM mount kit, keyboard, Clamp Base, Medium arm 8.5inch (215 mm)
<b>SVC1980i-SG3N</b>	Granit, Edge Service, GOLD, 1 Day, 3 Year, New Contract	

# RT10 FORKLIFT INSTALL

## Option 2 - WWAN - Keyboard - Bluetooth Scanner



**PART NUMBER DESCRIPTION**

<b>1</b>	RT10A-L1N-18C11SOx	RT10 WWAN / FlexRange / Device Client Pack
<b>2</b>	RT10-EVD	Enhanced Vehicle Dock, 10 to 60 VDC (Requires VM1055CABLE)
<b>3A</b>	RT10-2012BRKTKIT	RAM mount kit, keyboard, Round Base, Medium arm 8.5inch (215 mm)
<b>4</b>	9000160KEYBRD	Windows Laptop Style 95 key rugged keyboard with integrated 2 button mouse, DB9M USB Interface
<b>5</b>	VM1055CABLE	VM1, VM2, VM3 DC power cable right angle (spare)
<b>6</b>	1981IFR-3	Scanner, 1D/2D, FR focus (EX20), red, Bluetooth Class 1, with vibrator**

**OPTIONAL**

<b>7</b>	TOOLBAL	Scanner take up reel/balancer
<b>8</b>	VMHOLDER2K	Vehicle Mount Cup: Contains vehicle mount Granit scanner cup with 1' ball joint attachment. Recommended use with VMHOLDER3K (mounting arm with round attachment plate) or VMHOLDER4K (mounting arm with vehicle clamp), not included.

**SERVICE**

<b>SVCRT10-SG3N</b>	RT10, Edge Service, GOLD Maintenance Contract, 5 Day Turnaround, 3 Year, New Contract
<b>SVCACC-MOB3</b>	AddOn, Edge Service, Accessory Service, Mobility, 3 Year.
<b>3B</b> RT10-2015BRKTKIT	RAM mount kit, keyboard, Clamp Base, Medium arm 8.5inch (215 mm)
<b>SVC1981i-SG3N</b>	Granit, Edge Service, GOLD, 1 Day, 3 Year, New Contract

# RT10 FORKLIFT INSTALL

## Option 3 - WWAN - Tethered Scanner

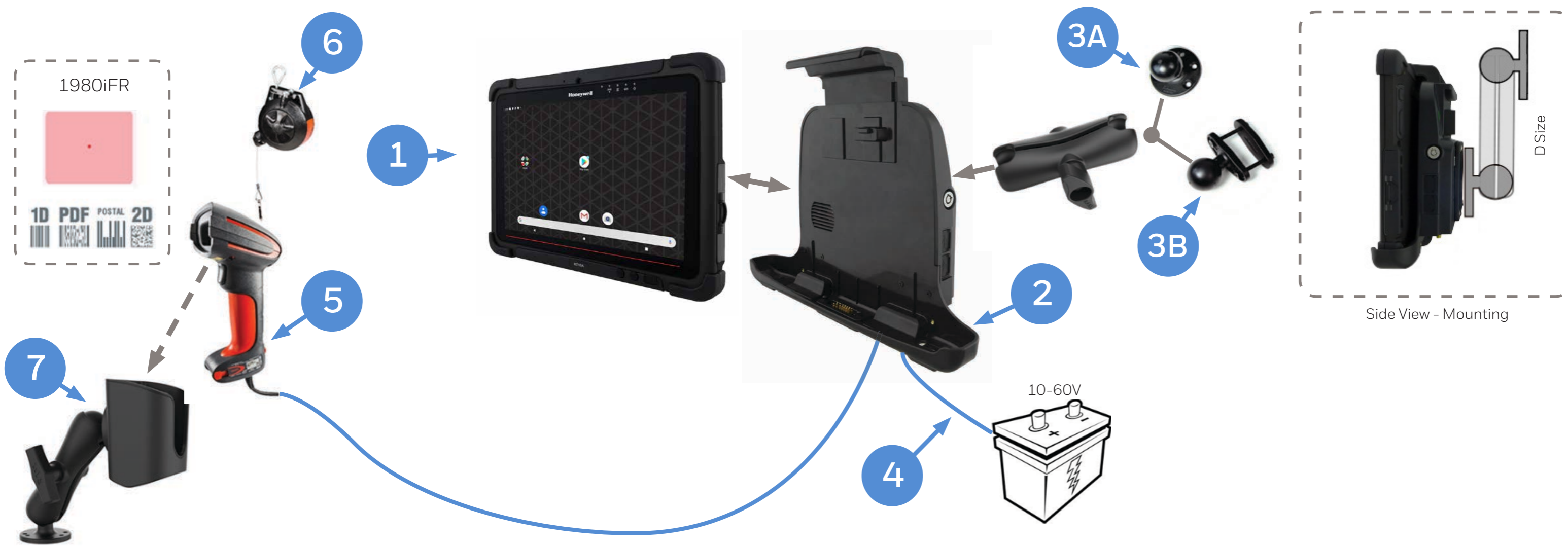

**PART NUMBER DESCRIPTION**

<b>1</b>	RT10A-L1N-18C11SOx	RT10 WWAN / FlexRange / Device Client Pack
<b>2</b>	RT10-EVD	Enhanced Vehicle Dock, 10 to 60 VDC (Requires VM1055CABLE)
<b>3A</b>	RT10-MNT-RAM	75x75mm VESA Plate with 2.25" diameter rubber ball "D" size.
	VX89A030RAMBALL	Ball, "D"-size 2.25in., <b>Round Base</b> 3.68in. base, typically mounts to vehicle.
	VX89A501RAMARM	RAM medium arm, 8.5in. (215mm) for "D"-size 2.25in. balls.
<b>4</b>	VM1055CABLE	VM1, VM2, VM3 DC power cable right angle (spare)
<b>5</b>	1980IFR-3SER	1980iFR-3: 1D/2D, FR focus (EX20), red scanner (1980iFR-3), RS232

**OPTIONAL**

<b>6</b>	TOOLBAL	Scanner take up reel/balancer
----------	---------	-------------------------------

**OPTIONAL**

<b>7</b>	VMHOLDER2K	Vehicle Mount Cup: Contains vehicle mount Granit scanner cup with 1" ball joint attachment. Recommended use with VMHOLDER3K (mounting arm with round attachment plate) or VMHOLDER4K (mounting arm with vehicle clamp), not included.
----------	------------	---

**SERVICE**

<b>SVCRT10-SG3N</b>	RT10, Edge Service, GOLD Maintenance Contract, 5 Day Turnaround, 3 Year, New Contract	
<b>SVCACC-MOB3</b>	AddOn, Edge Service, Accessory Service, Mobility, 3 Year.	
<b>3B</b>	RT10-MNT-RAM	75x75mm VESA Plate with 2.25" diameter rubber ball "D" size.
	VX89A031RAMBALL	Ball, "D"-size 2.25in., <b>Flat</b> 2.5in. <b>Clamp Base</b> , typically mounts to vehicle.
	VX89A501RAMARM	RAM medium arm, 8.5in. (215mm) for "D"-size 2.25in. balls.
<b>SVC1980i-SG3N</b>	Granit, Edge Service, GOLD, 1 Day, 3 Year, New Contract	

# RT10 FORKLIFT INSTALL

## Option 4 - WWAN - Bluetooth Scanner



	PART NUMBER	DESCRIPTION	SERVICE
	1	RT10A-L1N-18C11SOx RT10 WWAN / FlexRange / Device Client Pack	SVCRT10-SG3N RT10, Edge Service, GOLD Maintenance Contract, 5 Day Turnaround, 3 Year, New Contract
	2	RT10-EVD Enhanced Vehicle Dock, 10 to 60 VDC (Requires VM1055CABLE)	SVCACC-MOB3 AddOn, Edge Service, Accessory Service , Mobility, 3 Year.
	3A	RT10-MNT-RAM 75x75mm VESA Plate with 2.25" diameter rubber ball "D" size.	3B RT10-MNT-RAM 75x75mm VESA Plate with 2.25" diameter rubber ball "D" size.
		VX89A030RAMBALL Ball, "D"-size 2.25in., <b>Round Base</b> 3.68 in.W typically mounts to vehicle.	VX89A031RAMBALL Ball, "D"-size 2.25in., <b>Flat 2.5in. Clamp Base</b> , typically mounts to vehicle.
		VX89A501RAMARM RAM medium arm, 8.5in. (215mm) for "D"-size 2.25in. balls.	VX89A501RAMARM RAM medium arm, 8.5in. (215mm) for "D"-size 2.25in. balls.
	4	VM1055CABLE VM1, VM2, VM3 DC power cable right angle (spare)	
	5	1981IFR-3 Scanner, 1D/2D, FR focus (EX20), red, Bluetooth Class 1, with vibrator**	SVC1981i-SG3N Granit, Edge Service, GOLD, 1 Day, 3 Year, New Contract
<b>OPTIONAL</b>	6	TOOLBAL Scanner take up reel/balancer	
<b>OPTIONAL</b>	7	VMHOLDER2K Vehicle Mount Cup: Contains vehicle mount Granit scanner cup with 1" ball joint attachment. Recommended use with VMHOLDER3K (mounting arm with round attachment plate) or VMHOLDER4K (mounting arm with vehicle clamp), not included.	

# RT10 PORTS

## RT10W and RT10A I/O Ports



RT10W



RT10A



- 1x Micro HDMI
- 1x Micro SDXC slot
- 1x USB 3.0 (Type C)
- 1x USB 3.0 (Type A)
- 1x 3.5mm Audio Combo Connector (Mic in or line out)
- 1x DC jack



- 1x Micro SDXC slot
- 1x USB 3.0 (Type C)
- 1x USB 3.0 (Type A)
- 1x 3.5mm Audio Combo Connector (Mic in or line out)
- 1x DC jack



# RT10 BATTERY PACK

## Standard or Extended Battery

Select the battery pack to suit the deployment.

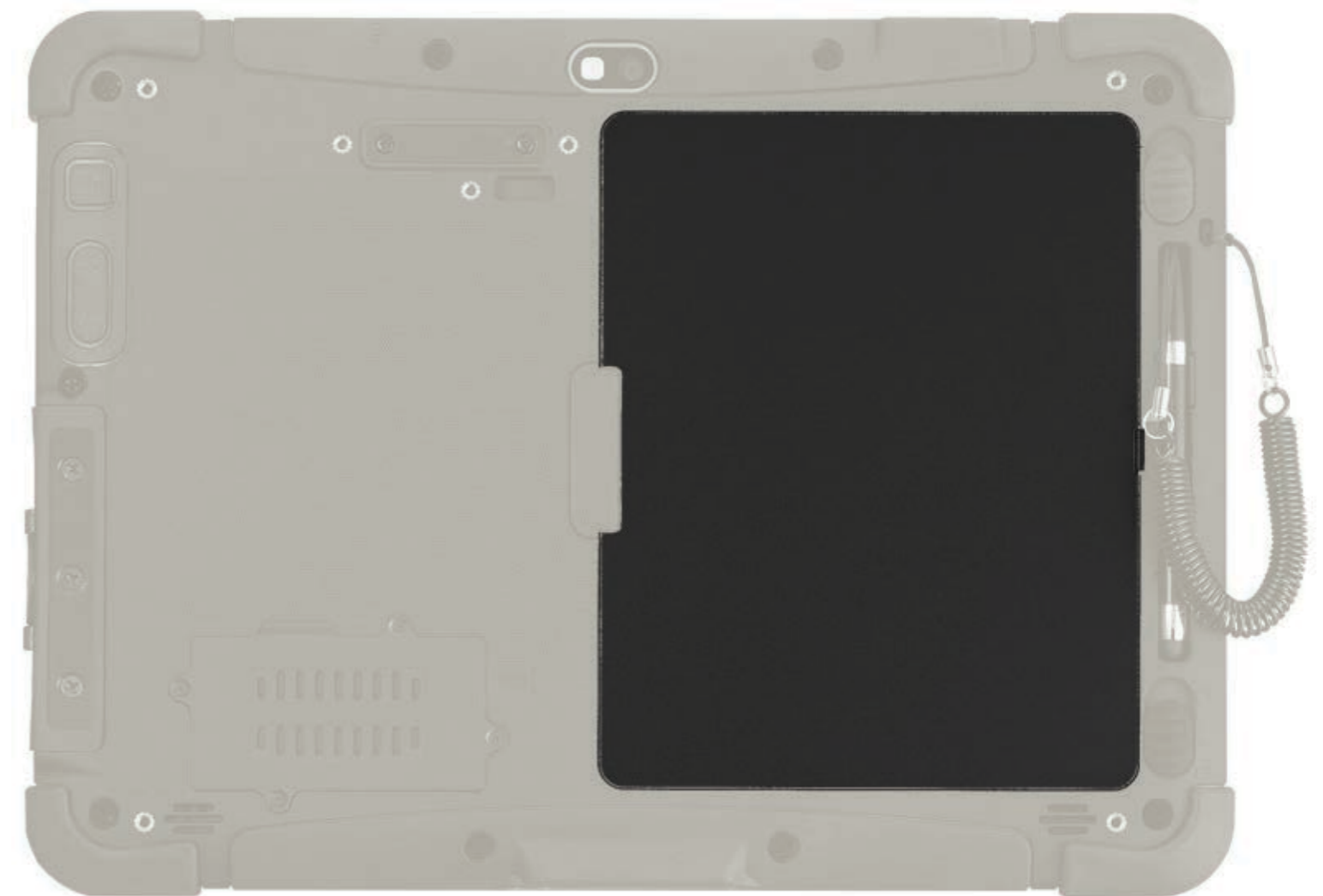

**Rear View**  
RT10 Battery Location

	<b>PART NUMBER</b>	<b>DESCRIPTION</b>
<b>1</b>	RT10-BAT-STD1	Spare Standard Battery. 7.7V 5,900 mAh Li-Polymer Battery, 276g weight, 11mm thickness.
<b>2</b>	RT10-BAT-EXT1	Spare Extended Battery. 7.4V 10,280 mAh Li-Polymer Battery, 474g weight, 16.5mm thickness.

# RT10 BATTERY CHARGER

## 2 Bay Battery Charging

Supports Batteries: RT10-BAT-STD1 Spare Standard Battery. 7.7V 5,900 mAh  
 RT10-BAT-EXT1 Spare Extended Battery. 7.4V 10,280 mAh



Batteries inserted in charger



PART NUMBER	DESCRIPTION
1 RT10-BC-2	2-bay battery charger for standard or extended batteries. 12-19V DC in power. Standard battery charges in 3hrs, Extended battery charges in 6hrs. Kit includes: 1 x 2-bay battery charger, 1 x 19V AC adapter. Requires country specific cord.

\*\* AC Power Cord – See Page 34 for Country Specific Power Cords

# RT10 ACCESSORIES

## Smart Card Reader

Smart Card Reader Attachment.



	PART NUMBER	DESCRIPTION
1	RT10-CAC	Smart card reader. Snaps onto the back of the tablet.

# RT10 VESA MOUNT

## Stationary Mounting

VESA Mount for permanent mounting of the RT10, used in combination with power supply as the plate restricts access to the battery.

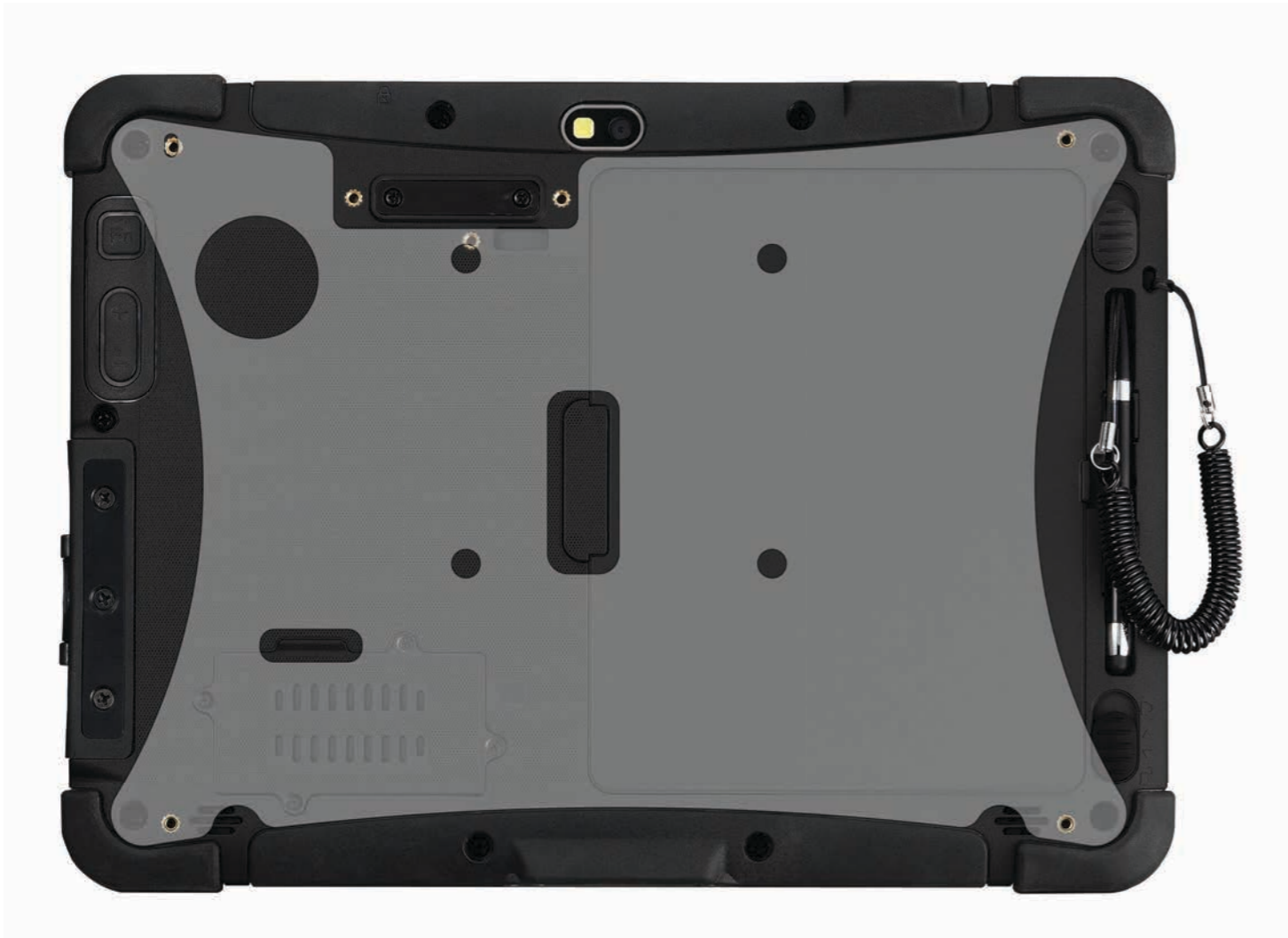

PART NUMBER	DESCRIPTION
1	RT10-MNT-VS 75x75mm VESA mount kit. SGCC grade steel. Includes 5x M4 6mm round screws, 5x M3 5mm round screws.

# GRANIT SCANNER OPTIONS

## Granit 1981i Bluetooth Accessories

### 1981i Bluetooth Spare Battery/ Charging



**PART NUMBER**    **DESCRIPTION**

BAT-SCN01A    Battery: Lithium-ion battery for Voyager 1202, 1452g, Xenon 1902, Granit 1911i, Granit 1981i, 3820 and 3820i cordless scanners (3.75V 2400mAh 9Wh)



**PART NUMBER**    **DESCRIPTION**

HOLSTER-INDUSTRIAL    When clipped to a user's belt holster enables storage of Granit 1911i and 1981i cordless imagers while leaving hands-free to accomplish other tasks (scanner sold separately)



**PART NUMBER**    **DESCRIPTION**

MB4-BAT-SCN01NAWO    Charger: 4-bay battery charger (NA) for use with Voyager 1202g, 1452g, Xenon 1902, Granit 1911i, Granit 1981i, 3820, 3820i, Lithium-ion batteries, NA wallmount power supply (PS-050-4000W-NA), two mounting screws (100006897), and Instructions (MBC-INST)



**PART NUMBER**    **DESCRIPTION**

50110266-001FRE    END CAP, CORDLESS, 1911i & 1981i



**PART NUMBER**    **DESCRIPTION**

COB02    Charge-Only Base: only 1 scanner can be charged at a time, power supply must be purchased separately. Select appropriate regional Power Supply PS-05-1000W-x

PS-05-1000W-A    Power Supply: North America plug, 1.0A @ 5.2 VDC 90-255VAC @ 50-60Hz

PS-05-1000W-C    Power Supply: EU plug, 1.0A @ 5.2VDC 90-255VAC @ 50-60Hz

PS-05-1000W-U    Power Supply: UK plug, 1.0A @ 5.2 VDC 90-255VAC @ 50-60Hz

PS-05-1000W-I    Power Supply: Australia, New Zealand plug, 1.0A @ 5.2 VDC 90-255VAC @ 50-60Hz

# GRANIT SCANNER OPTIONS

## Granit 1980i - Serial Cable Types

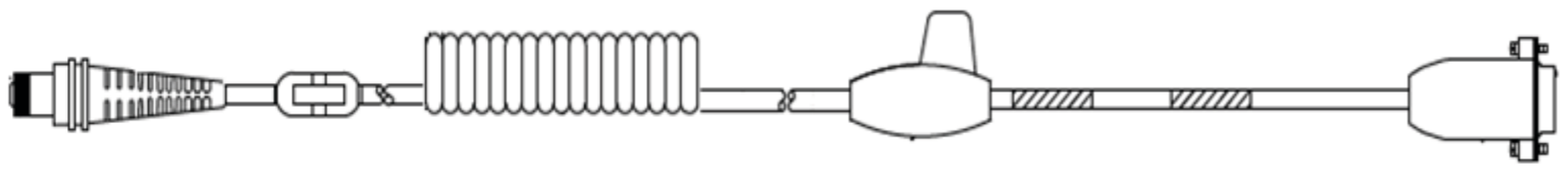
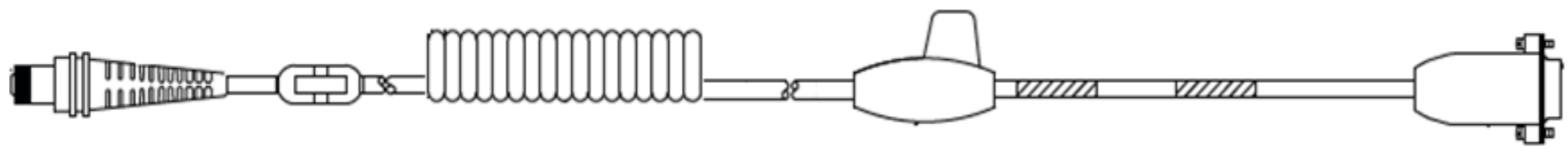
SERIAL					
<b>CBL-020-300-C00-01</b>	Cable - Industrial: RS232 (5V signals), black, DB9 Female, 3m (9.8'), coiled, 5V external power with option for host power on pin 9	3m	COILED		
					
<b>CBL-020-500-C00-01</b>	Cable - Industrial: RS232 (5V signals), black, DB9 Female, 5m (16.4'), coiled, 5V external power with option for host power on pin 9	5m	COILED		
					



# GRANIT SCANNER OPTIONS

## Granit 1980i - USB Cable Types

USB				
<b>CBL-501-300-S00</b>	CABLE, USB,9PIN DB9 MALE 5V, INDUSTRIAL	3m	STRAIGHT	Connect direct to the Smart Dock to DB9F USB/USB1 Port



Note: This cable only supports USB Keyboard (PC) interface.

# MISCELLANEOUS

## Hand Strap

Adjustable buckle for changing battery easily.

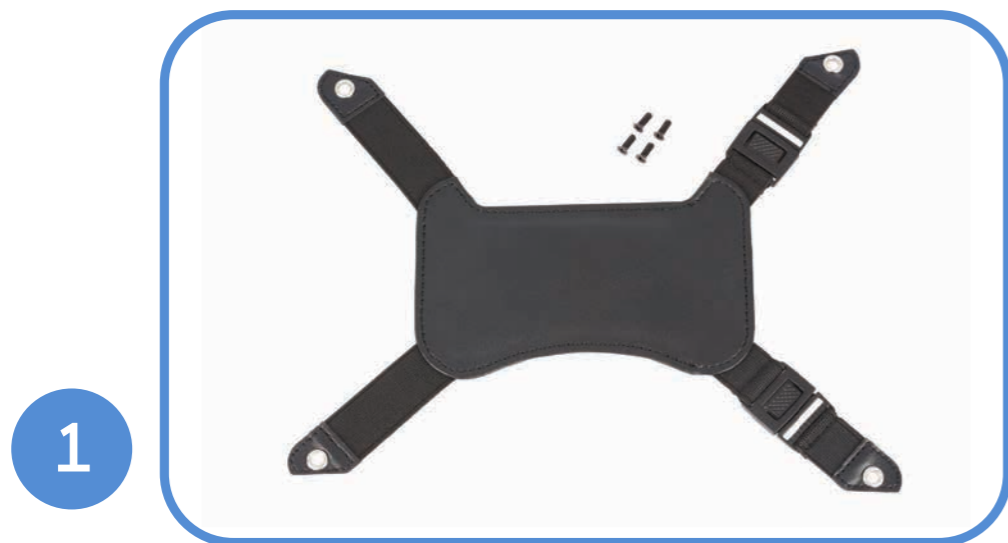

1



**PART NUMBER**      **DESCRIPTION**

1      RT10-HS-1      Hand strap kit including screws. Adjustable for Standard or Extended battery sizes.

## Shoulder Strap

Strap length adjustable (85cm ~ 165cm).



1



**PART NUMBER**      **DESCRIPTION**

1      RT10-SS-1      Shoulder strap kit including screws. Adjustable cross body strap with pad.



# MISCELLANEOUS

## Stylus



1

PART NUMBER	DESCRIPTION
1 RT10-STY-1	Replacement capacitive stylus with tether.

## Carry Bag



1

PART NUMBER	DESCRIPTION
1 RT10-CASE	Carry bag with hand carrier and adjustable shoulder strap. Separated pocket for accessories.

# MISCELLANEOUS

## Optional Parts



PART NUMBER	DESCRIPTION
VX89351PWRSPLY	Screen Blanking Switch Box Requires VM1080CABLE



PART NUMBER	DESCRIPTION
VM1080CABLE	Screen Blanking Box Cable VM1 screen blanking box cable D9F to bare wires, 6ft. (1.8m).



PART NUMBER	DESCRIPTION
RT10-SCREEN-FILM1	RT10 Screen Protectors (Pack of 1)

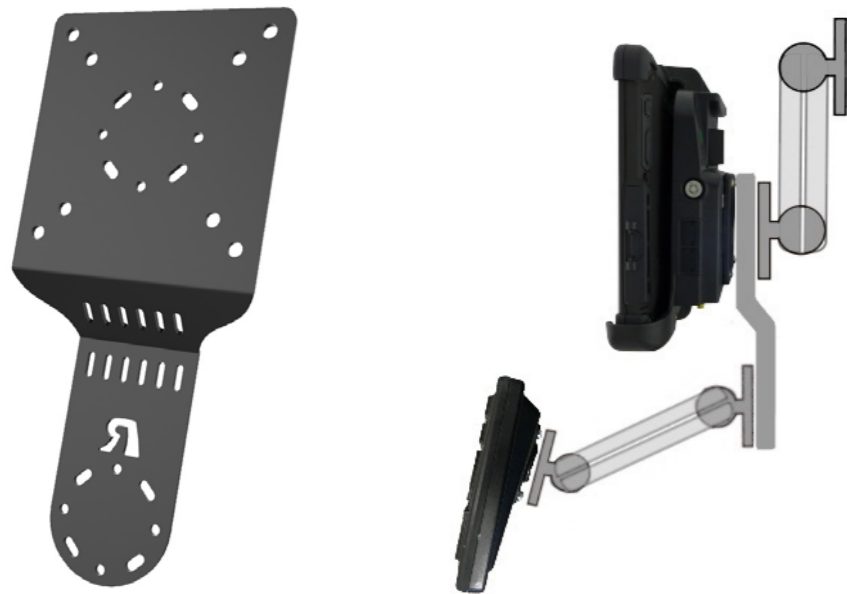

PART NUMBER	DESCRIPTION
RT10-KEYBD-PLATE	RT10 keyboard plate adapter (C-Size RAM mount or keyboard are not included)



PART NUMBER	DESCRIPTION
RT10-MNT-RAM	75x75mm VESA Plate with 2.25" diameter rubber ball "D" size.



PART NUMBER	DESCRIPTION
RT10-MNT-RAM-C	75x75mm VESA Plate with 1.5" diameter rubber ball "C" size.

# MISCELLANEOUS

## Micro-SD Cards

Honeywell Recommended – ATP Industrial Grade Micro SD Cards



Why ATP Industrial Grade SD?

ATP's SIP (System-In-Packaging) manufacturing process encapsulates all exposed components and points of failure to ensure the products are fully waterproof, shockproof, and ESD (Electro-Static Discharge) proof. ATP Industrial Grade SD/SDHC Cards can withstand at least an operating/storage temperature range of at least -40 to 85 degrees Celsius. In addition to this temperature range, the cards are completely waterproof, dustproof, and ESD (Electro-Static Discharge) proof. All ATP Industrial Grade SD/SDHC cards are produced under a stringent RoHs and Green Package compliant manufacturing process to guarantee a consistent high level of build quality and performance. ATP Industrial SD cards deliver outstanding performance with read speed (seq) up to 18MB/sec and write speed (seq) up to 16MB/sec. All ATP Industrial Grade CF, SD, USB drives, and SSDs are constructed using best-in-class SLC(Single-Level Cell) components with enhanced Error Correction Code(ECC) functions and wear levelling algorithms. This results in MTBF ratings over 2 million hours and the highest write cycle lifetimes in the industry.

	PART NUMBER	DESCRIPTION
<b>1</b>	856-065-004	MICRO-SD CARD, <b>1GB</b> , AFIGUDI, ROHS
<b>OR</b>	856-065-005	MICRO-SD CARD, <b>2GB</b> , AFIGUDI, ROHS
<b>OR</b>	856-065-006	MICRO-SD CARD, <b>4GB</b> , AFIGUDI, ROHS
<b>OR</b>	856-065-007	MICRO-SD CARD, <b>8GB</b> , AFIGUDI, ROHS

## AC Cords

Regional Power Cords



AC Power - C6 Type Connector

PART NUMBER	DESCRIPTION
RT10-PWR-CABLE-US	C6 type power cable, USA
RT10-PWR-CABLE-EU	C6 type power cable, Europe
RT10-PWR-CABLE-DMK	C6 type power cable, Denmark 3-pin
RT10-PWR-CABLE-ITAL	C6 type power cable, Italy 3-pin
RT10-PWR-CABLE-SWIZ	C6 type power cable, Switzerland 3-pin
RT10-PWR-CABLE-UK	C6 type power cable, UK 3-blade
RT10-PWR-CABLE-AUS	C6 type power cable, Australia

# MISCELLANEOUS

## Disclaimer

---

Honeywell International Inc. (“HII”) reserves the right to make changes in specification and other information contained in this document without prior notice, and the reader should in all cases consult HII to determine whether any such changes have been made. The information in this publication does not represent a commitment on the part of HII.

HII shall not be liable for technical or editorial errors or omissions contained herein; nor for incidental or consequential damages resulting the furnishing, performance, or use of this material.

This document contains proprietary information that is protected by copyright. All rights are reserved. No part of this document may be photocopied, reproduced, or translated into another language with-out prior written consent of HII.

Web Address: [www.honeywellaidc.com](http://www.honeywellaidc.com)

The Bluetooth trademarks are owned by Bluetooth SIG, Inc., U.S.A and licensed to Honeywell.

Thor and Mobility Edge are trademarks or registered trademarks of Honeywell International Inc. in the United States and/or other countries.

Android is a trademark or registered trademark of Google Inc. in the United States and/or other countries. Windows is a trademark or registered trademark of Microsoft Corporation.

Qualcomm and Snapdragon are trademarks or registered trademarks of Qualcomm Incorporated in the United States and/or other countries.

Intel and Pentium are trademarks or registered trademarks of Intel Corporation.

Other product names mentioned in the manual may be trademarks of registered trademarks of their respective companies and are the property of their respective owners.

All rights reserved.

### For more information

[www.honeywellaidc.com](http://www.honeywellaidc.com)

### Honeywell Safety and Productivity Solutions

9680 Old Bailes Road

Fort Mill, SC 29707

800-582-4263

[www.honeywell.com](http://www.honeywell.com)